



## Small Animal Hut



*Photo may show a different but similar model.*

©2023

All Rights Reserved. Reproduction is prohibited without permission.



WARNING: Cancer and Reproductive Toxicity - P65Warnings.ca.gov

STK#	DIMENSIONS
105218	12' W x 6' 5" H x 12' 2" L

Revision date: 02.13.23



### READ THIS DOCUMENT BEFORE YOU BEGIN.

Thank you for purchasing this ClearSpan™ animal hut. When properly assembled and maintained, this product will provide years of reliable service. These instructions include helpful hints and important information needed to safely assemble and properly maintain the animal hut. Please read these instructions **before** you begin.

If you have any questions during the assembly, contact Customer Service for assistance.

### SAFETY PRECAUTIONS

- Wear eye protection.
- Wear head protection.
- Wear gloves when handling metal tubes.
- Use a portable GFCI (Ground Fault Circuit Interrupter) when working with power tools and cords.
- Do not climb on the animal hut or framing during or after construction.
- Do not occupy the animal hut during high winds, tornadoes, or hurricanes.

### ANCHORING INSTRUCTIONS

Prior to assembling this animal hut, please read the **MUST READ** document included with the shipment.

**⚠ WARNING:** The anchor assembly is an integral part of the hut construction. Improper anchoring may cause hut instability and failure of the structure to perform as designed. Failing to anchor the hut properly *will void the manufacturer's warranty* and may cause serious injury and damage.

Consult your sales representative for anchoring products and assistance. *You must anchor the assembled animal hut to the site. Anchoring components are not included with the animal hut and must be ordered separately.*

### LOCATION

Choosing the proper location is an important step before you begin. The following suggestions and precautions will help you determine whether your selected location is the best location.

- Never erect the structure under power lines.
- Identify whether underground cables and pipes are present *before* preparing the site or anchoring the structure.
- Location should be away from structures that could cause snow to drift on or around the animal hut.
- Do not position the animal hut where large loads such as snow and ice, large tree branches, or other overhead obstacles could fall.

### SITE

After choosing a location, proper preparation of the site is essential. Follow the information below helps to ensure the integrity of the structure.

- *A level site is required.* The site must be level to properly and safely erect and anchor the structure.
- **Drainage:** Water draining off the structure and from areas surrounding the site should drain away from the site to prevent damage to the site, the structure, and contents of the structure.

**⚠ WARNING:** The individuals assembling this structure are responsible for designing and furnishing all temporary bracing, shoring and support needed during the assembly process. For safety reasons, those who are not familiar with recognized construction methods and techniques must seek the help of a qualified contractor.

## ASSEMBLY PROCEDURE

Following the instructions as presented will help ensure the proper assembly of your animal hut. An improperly assembled and anchored animal hut will void all warranty and protection the owner is entitled to.

The steps outlining the assembly process are as follows:

1. Verify that all parts are included in the shipment. Notify Customer Service for questions or concerns.
2. Read these instructions, the Must Read document, and all additional documentation included with the shipment **before** you begin.
3. Gather the tools, bracing, ladders (and lifts), and assistance needed to assemble the animal hut.
4. Check the weather **before** you install any panels. Do not install panels on a windy or stormy day.
5. Assemble the frame components in the order they are presented in these instructions.
6. Consult the MUST READ document and properly anchor the assembled frame.
7. Install, tighten, and secure the main cover panels.
8. Read the care and maintenance information at the end of these instructions.
9. Complete and return all warranty information as instructed.

## LIST OF WORDS AND PHRASES

Before you begin, it is important to become familiar with the words and phrases used in this instruction manual.

These words and phrases are common to most ClearSpan™ shelters and identify the different parts of the shelter. (Some are used in this document. Others may not apply to this particular shelter.) These terms describe the shipped parts and can also be found on the materials list/spec sheets included with the shipment. To aid in the assembly, read through the following definitions before you begin.

- **Foot or Rafter Foot:** The part attached to and found at the base of the rafter or leg of the shelter. Depending on the shelter, the foot is an optional purchase. Some shelters do not offer an optional foot. Some use 1-way connectors; others use ground posts.
- **Must Read Document:** This document includes building and shelter anchoring instructions, steps for end wall reinforcement, safety precautions, and notices and warnings. The Must Read document is sent with all shelters and buildings. If you did not receive a Must Read document, contact Customer Service to request one.
- **On-Center:** Term used to describe a measurement taken from the vertical center of the rafter or frame member to the vertical center of another.
- **Purlin:** The pipe assembly that runs perpendicular to the rafters or framework that supports the main cover. Purlins are found on the sides and roof areas of the assembled frame, are evenly spaced, and typically run from the front to the back of the shelter.
- **Plain or Straight Pipe:** A term used to describe a pipe that has the same diameter or width throughout its entire length.
- **Strut:** A strut is usually a length of pipe with two flattened ends and is used for diagonal bracing of the shelter frame. A strut is typically secured to the frame work by special brackets and bolts.
- **Swaged End or Swaged Pipe:** The term “swaged” refers to the tapered end of the pipe or tube. Swaged ends of a pipe can be inserted into couplers and the straight ends of other pipes.
- **Tek screw:** A self-tapping fastener used to secure pipe joints and to fasten brackets to rafters.
- **Conduit:** An assembly of pipes used to secure the main cover and end panels (if equipped). Purlins and some strut assemblies also consist of connected pipes to form a conduit. Each pipe joint of a conduit assembly is secured with a self-tapping Tek screw.
- **Coupler or Fitting:** A part of the frame assembly where legs, purlins and rafter pipes are inserted and secured. In most instances, 3-way and 4-way couplers are used. In some larger applications, couplers are used to secure the joints of the different rafter sections during the assembly of the rafters. Some shelters do not use couplers.

## SMALL ANIMAL HUTS

### REQUIRED TOOLS

The following list identifies the main tools needed to assemble the animal hut. Additional tools and supports may be needed depending on the structure, location, and application.

- Tape measure or measuring device and marker.
- Variable speed drill and impact driver (cordless with extra batteries works best) to install screws.
- Hammer and gloves.
- Saw to cut metal tubes for assembly.
- Magnetic nut setter (3/8" x 2-9/16")



This space is reserved for customer notes.



### UNPACK AND IDENTIFY PARTS

The following steps will ensure that you have all the necessary parts before you begin.

1. Unpack the contents of the shipment and place where you can easily inventory the parts. Refer to the Bill of Materials/Spec Sheets.
2. Verify that all parts listed on the Bill of Materials/Spec Sheets are present. If anything is missing or you have questions, consult the Pictorial Parts Guide, the Quick Start Guide, and all diagrams for clarification, or contact Customer Service.

**NOTE:** At this time, you do not need to open the plastic bags containing smaller parts such as fasteners or washers.

### QUICK START GUIDE

For a quick overview of this animal hut and its components, consult the Quick Start Guide at the back of these instructions.



The following graphics will help you identify the different parts. (Some parts are not shown.)



FA4482B  
Tek Screw



FA4484B  
Tek Screw



102921B  
Washer

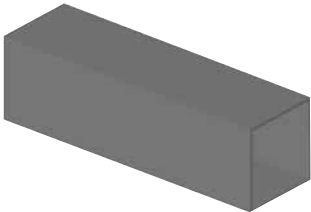

104601P2  
1.75" Square Tube

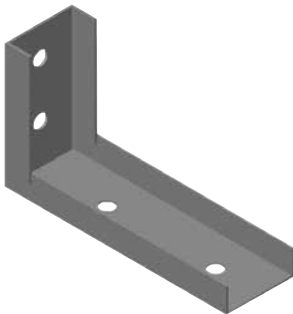

QH1330  
Angled Bracket

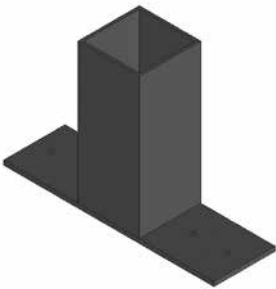

104624  
1-Way Tube Fitting



104645  
3" x 3" Bracket

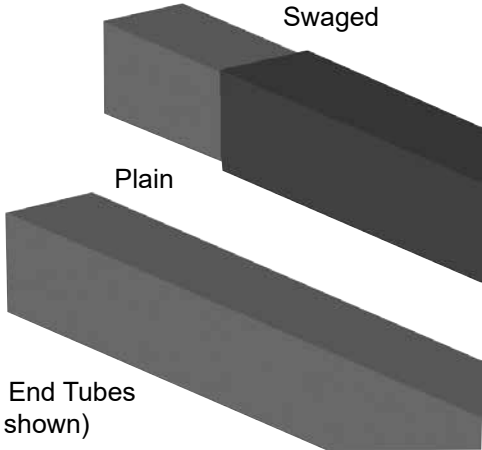

Swaged and Plain End Tubes  
(not all pieces are shown)



## Small Animal Hut

### ASSEMBLE THE BASE

This section describes how to assemble the base. See illustration below to identify main parts of the base. Consult Quick Start section for details.

1. Locate the required fittings and pipes to assemble the base as shown below.
2. Using one (1) 96" square tube (#104779), cut two (2) 48" sections for the base frame members. These cut tubes will be used for the end base frame members.
3. Cut another 104779 square tube into two (2) 45" sections for end base frame members.
4. Locate the remaining square tubes needed, four (4) 102897, and assemble the base frame.
5. Secure all fittings and base frame members using FA4482 Tek screws.

**END TUBE:** Set a 106624 1-way fitting on the side base rail to properly attach the end base rail tube. See the diagram below.

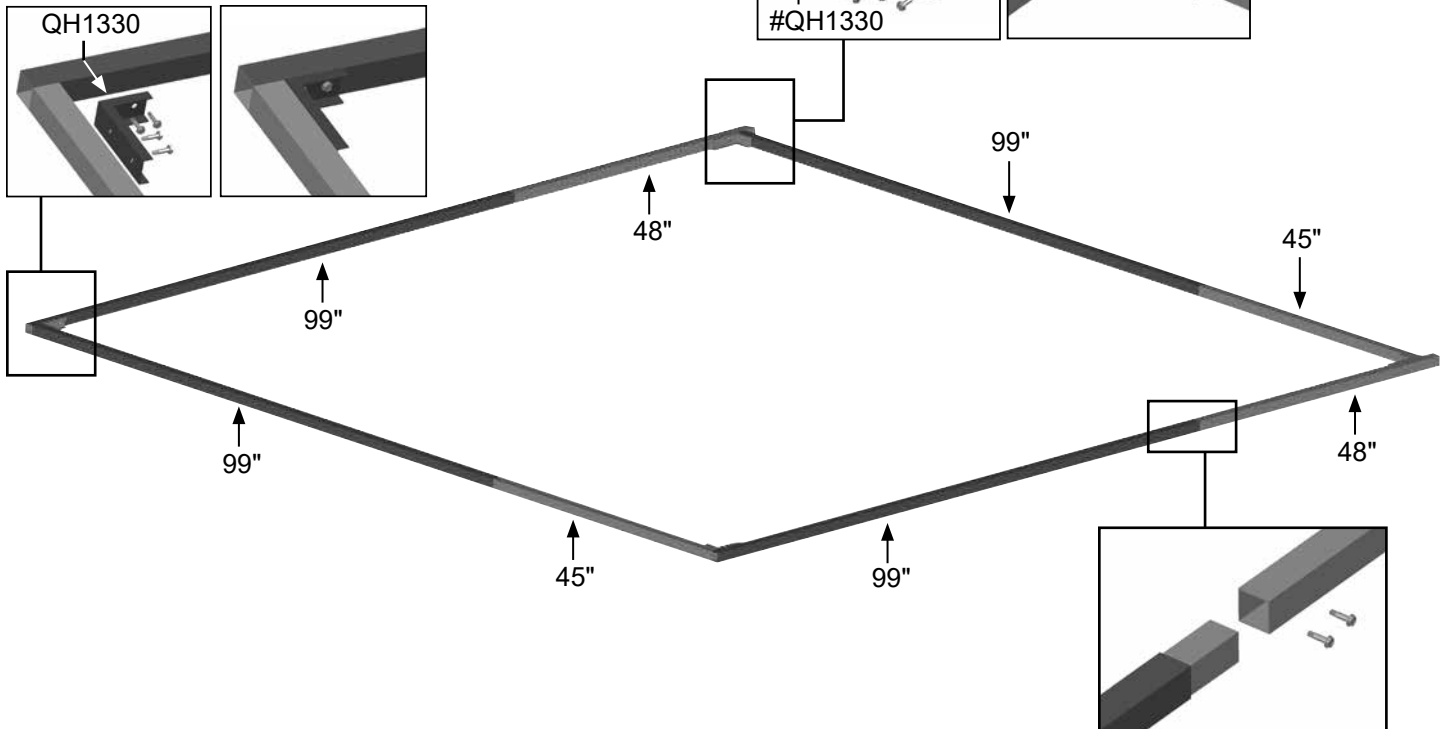
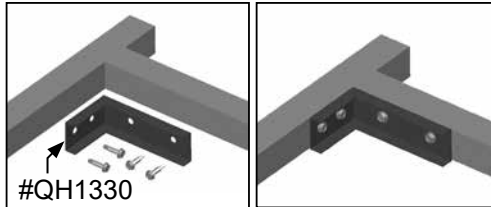
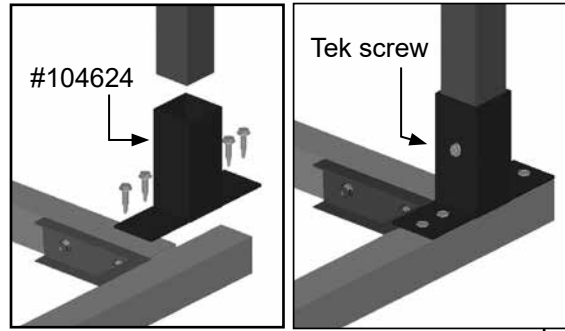



**RAFTER ASSEMBLY**

This section describes how to assemble the rafters. The illustration below identifies main parts of the assembly.

1. Locate the required fittings and pipes to assemble each rafter as shown below.

**NOTE:** *End rafter only:* Cut two (2) 104779 square tubes at 75-1/4" each and attach to the end rafter using a 3" x 3" bracket (#104645) as shown to the right.

Install a total of two (2) upper brackets on the inside of the end rafter (shown below) and two (2) lower brackets to the outside of the end rafter (see diagrams on the following page).

2. Secure all fittings and base frame members using FA4482 Tek screws.

**ATTENTION:** Install the screws so they do not interfere with the installation of the panels.

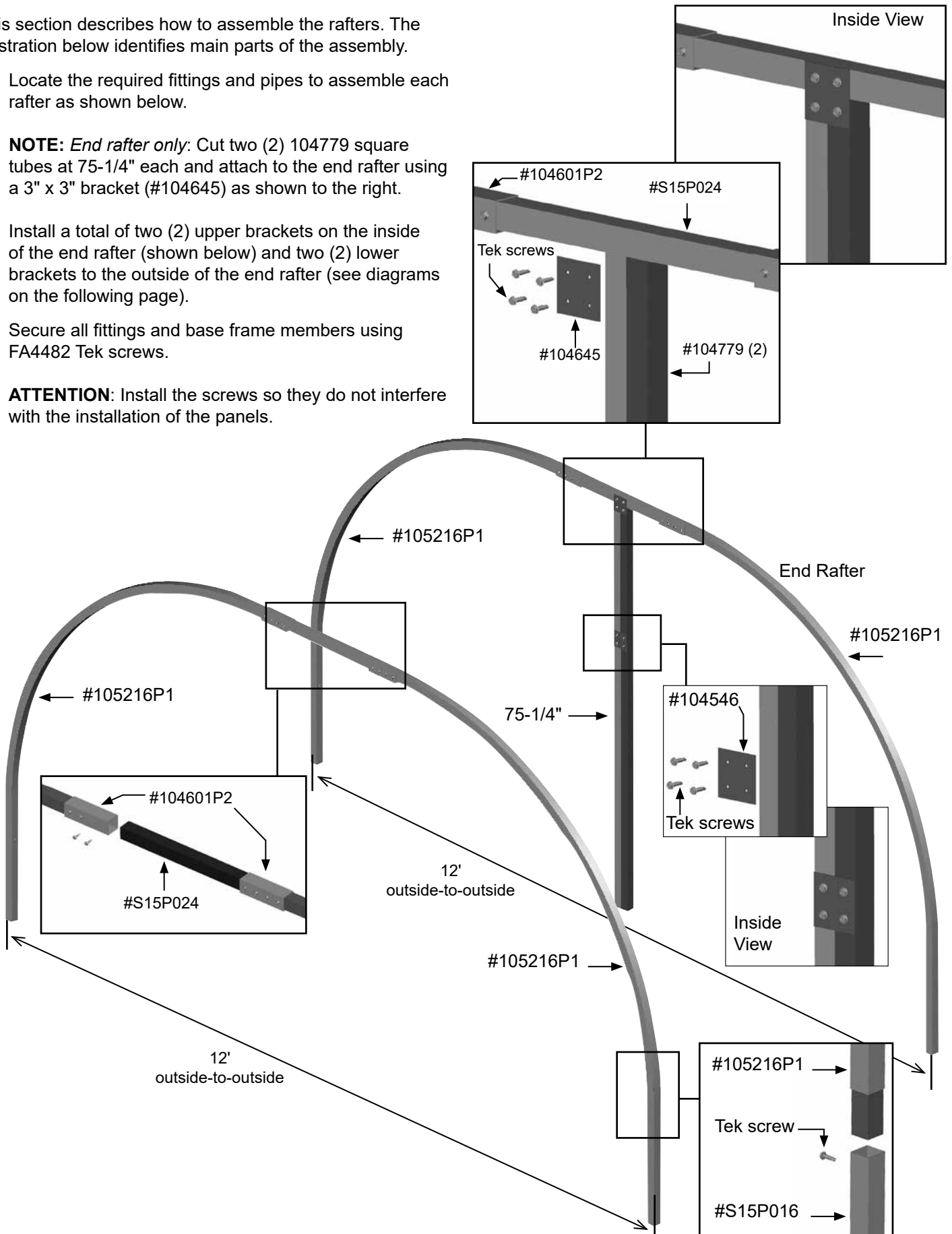

## SMALL ANIMAL HUTS

### ASSEMBLE THE FRAME

This section describes how to assemble the frame. See illustration below to identify main parts of the frame. Consult Quick Start section for details.

1. Locate the required fittings and rafters to assemble the frame as shown below.
2. Secure all frame fittings and rafters using FA4482 Tek screws.

**ATTENTION:** Install the screws so they do not interfere with the installation of the panels. Verify that the rafters are spaced properly as shown.

3. Anchor the frame to the site. Consult your sales representative for anchoring suggestions. *Failing to anchor the shelter to the site may cause property damage and injury and will void the warranty.*

*Anchoring components are not included with the animal hut and can be purchased separately.*

The two (2) lower brackets are attached to the end wall vertical frame supports on the outside of the end rafter.

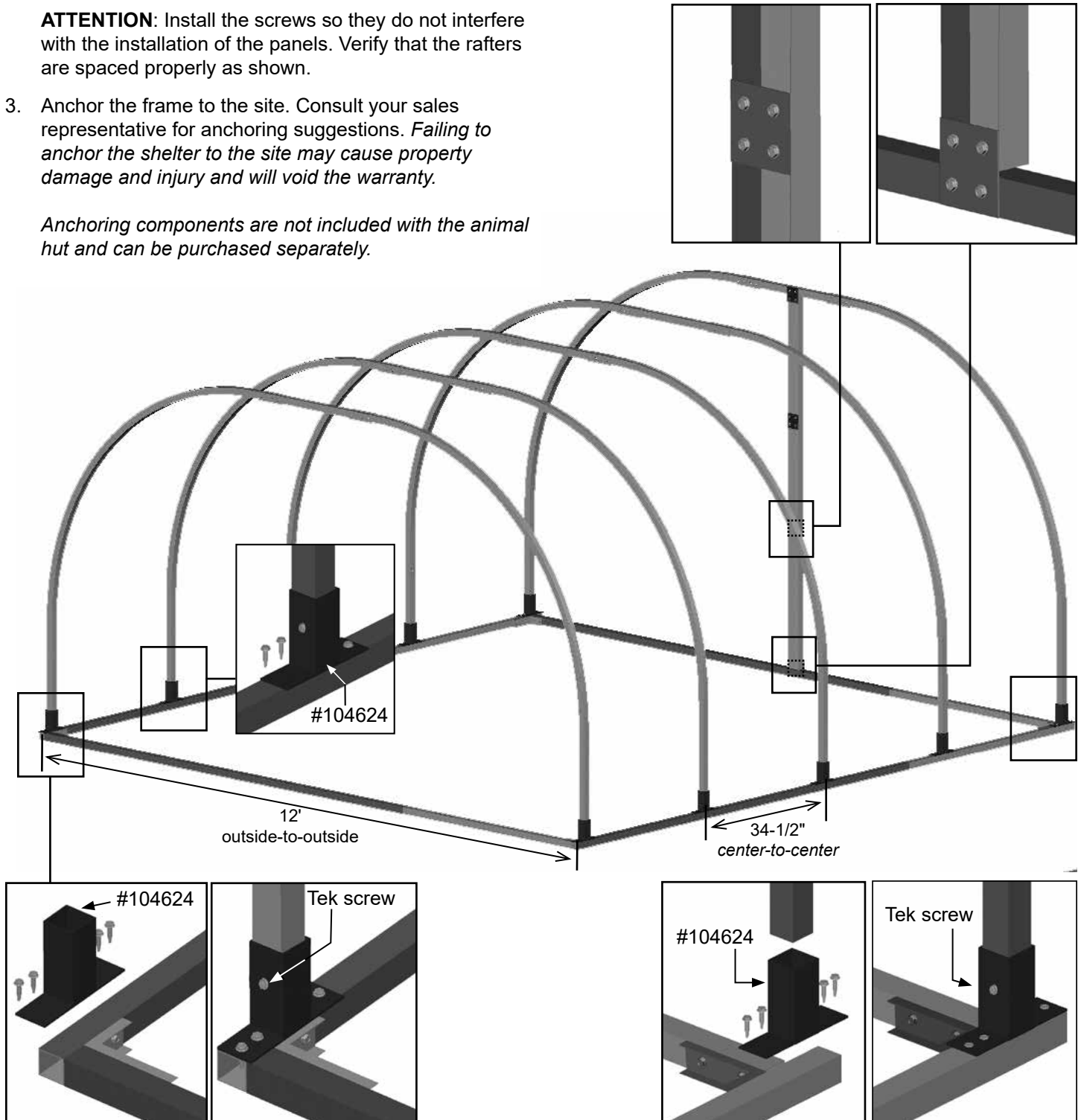



**INSTALL THE END PANEL**

After the frame is properly anchored, install the end panel.

Gather the parts:

- Two XR7110L corrugated straight panels (30" x 72")
- One XR7110NR corrugated arched panel
- One XR7110NL corrugated arched panel
- One XR7110MR corrugated clipped panel (30" x 72")
- One XR7110ML corrugated clipped panel (30" x 72")
- FA4484 Tek screws
- 102921B Neo-bonded washers

**NOTE:** Assistance is required to install all panels. Divide the Tek screws and washers between the end panel installation and the remaining rafters. *Space all Tek screws evenly and install in the valleys of the panels.*

**⚠ WARNING:** To prevent property damage and personal injury, do not install the end panels or main cover on a windy or stormy day.

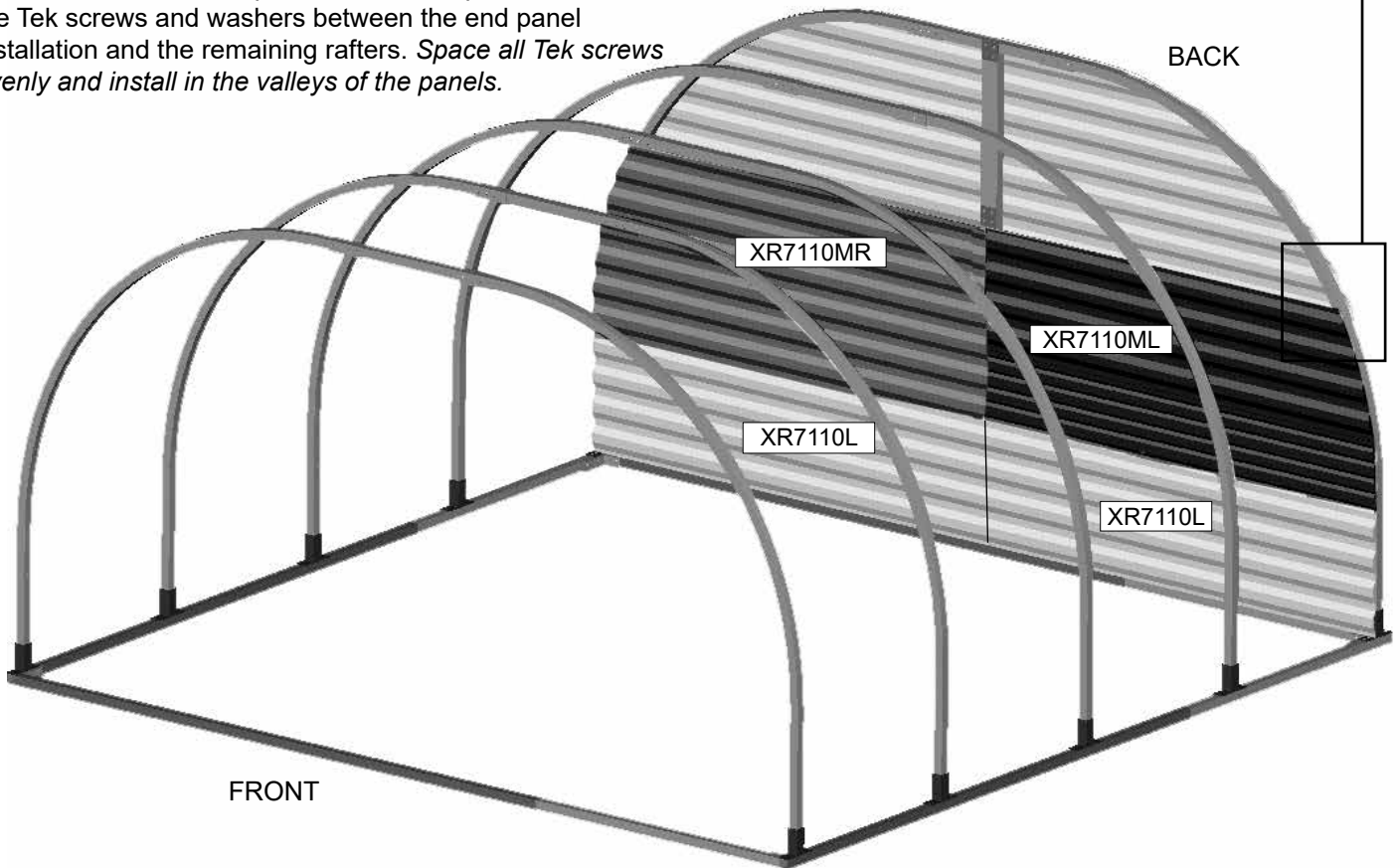
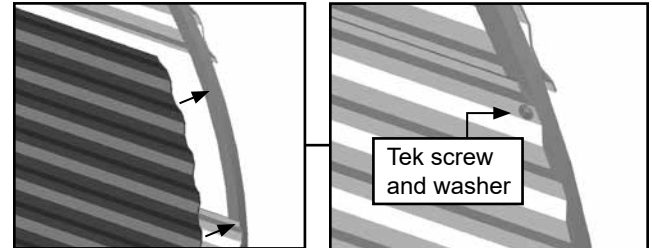

1. Attach the arched panels (XR7110NR and XR7110NL) to the end rafter (center post) on the outside of the shelter using Tek screws and washers. See insert to the right.
2. On the inside of the shelter, attach the remaining panels to the end wall using Tek screws and washers as shown in the photo above.
3. Continue with installing the cover.

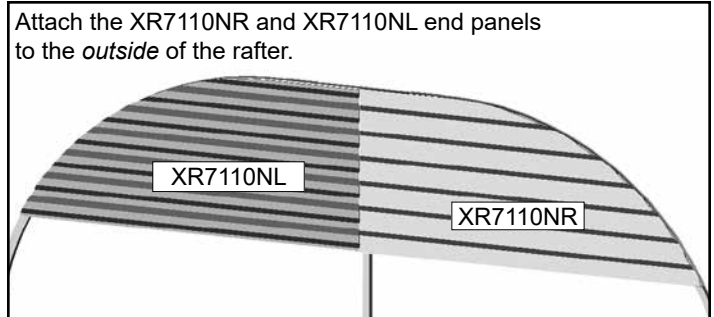

View shows the panels as seen standing on the outside of the frame looking at the back of the shelter.

## SMALL ANIMAL HUTS

### ATTACH MAIN COVER PANELS

Begin by installing one lower panel and work up and over the frame to the final lower panel. Upper panels overlap the lower side panels; install fasteners through both panels at the point of overlap to secure. *A level surface is required to install the panels correctly and squarely on the frame.*

**ATTENTION:** *Do not overlap the panels too much.* Place upper panels in position before securing them to the frame to determine the required overlap needed and to ensure the panels cover the entire frame. During panel installation, *it may be necessary to adjust the position of the panels to allow the ribs of two different panels to align.* Loosen mounting screws and retighten or reposition if needed

Gather the parts:

- XR7005 Corrugated PolyMax panels (52-1/8" x 146")
- FA4484 Tek screws and 102921 Neo-bonded washers

Maintain the on-center dimension for the mid rafter as you install the Tek screws and washers through the panels. *Do not install all screws at this time.* The final screws for the upper panels are installed as each panel is slid into position.

Divide the remaining Tek screws and washers evenly between the remaining rafters and space evenly during installation. Install fasteners in the valleys of the panels.

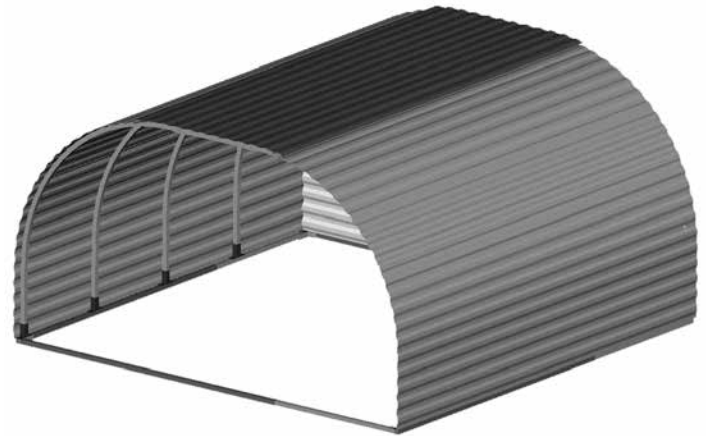

**Do not install screws through the upper panels where these overlap until the next panel is installed.**

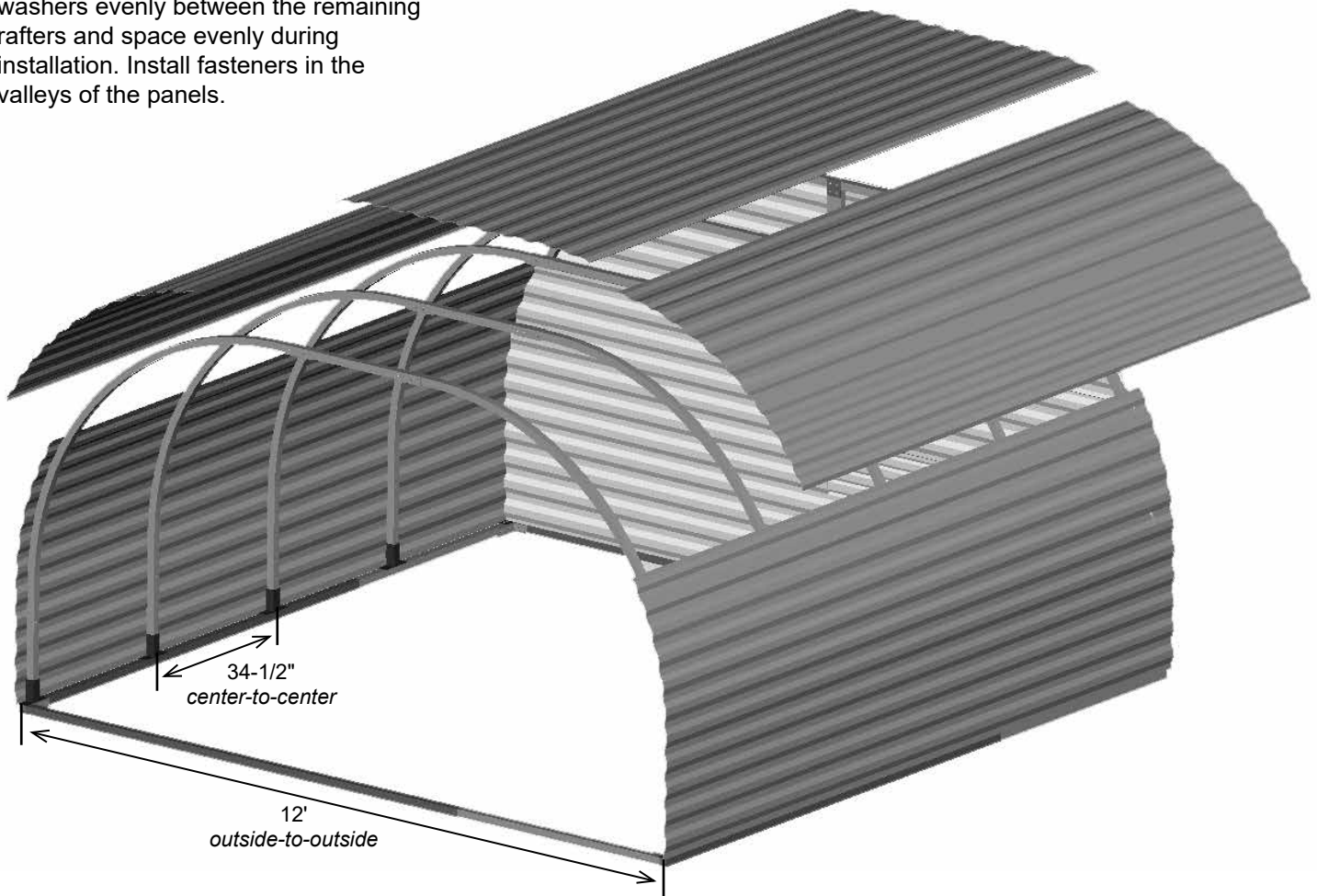

### CARE AND MAINTENANCE

Proper care and maintenance of the animal hut will help to ensure years of service. The following items identify areas that should be periodically checked to ensure that your animal hut is maintained properly:

- Regularly check the panels to see that they remain tight and in proper repair.
- Check connections and all fasteners to verify that they remain tight.
- Do not climb or stand on the animal hut at anytime.
- Remove debris and objects that can accumulate on the animal hut. Use tools that will not damage the cover when removing debris.
- Remove snow to prevent excess accumulation. Use tools that will not damage the cover when removing snow.
- Check the anchoring system to ensure that all components are tight and in good repair.
- If the animal hut is moved, inspect all parts and connections before reassembling and anchoring.

**NOTE:** With the exception of Truss Arch buildings, ClearSpan™ shelters and greenhouses *do not* have any tested loading criteria.

### ANCHORING INSTRUCTIONS

Prior to assembling this animal hut, please read the **MUST READ** document included with the shipment.

**⚠ WARNING:** The anchor assembly is an integral part of the animal hut. Improper anchoring may cause shelter instability and failure of the structure to perform as designed. Failing to anchor the animal hut properly *will void the manufacturer's warranty* and may cause serious injury and damage.

Consult your sales representative for anchoring products and assistance. *You must anchor the assembled animal hut to the site. Anchoring components are not included with the animal hut and must be ordered separately.*

### OPTIONAL GROUND ANCHOR (#104778)

Ground posts are *not included* with the shipment and must be ordered *separately*. Contact Customer Service to purchase ground posts.

The following instructions describe one way to anchor your shelter using ground posts.

Gather the parts:

- Ground posts (#104543D)
  - 5/16" x 3-1/2" carriage bolts
  - 5/16" nuts and washers
1. Identify a corner where a ground post will be positioned and drive the first ground post into the ground.

**NOTE:** *The top of the post will be six (6") inches above the finished grade when properly driven.*

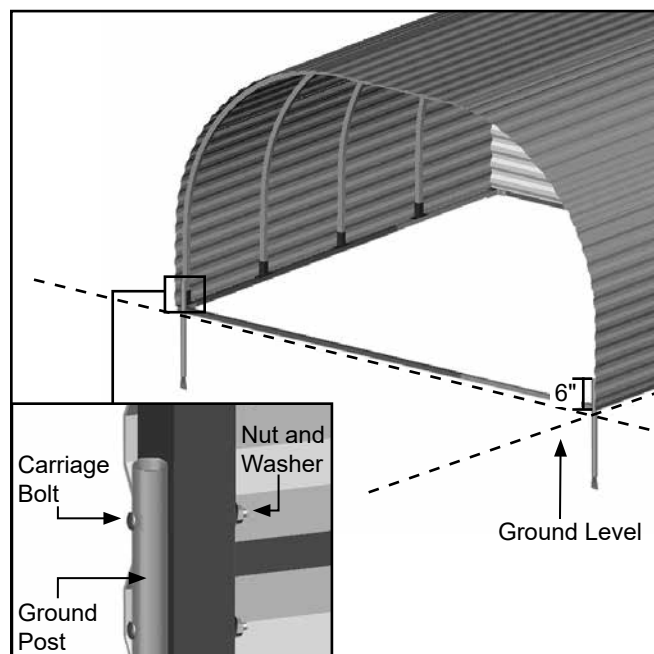

**ATTENTION:** Position the pre-drilled holes facing to the inside/outside of the shelter so they can be aligned with the rafter legs.

2. After the first corner ground post is in place, measure the width required and drive the next corner ground post. (This will be the width of the shelter.)
3. After driving the first two (2) corner posts and setting the shelter against the ground posts, drill 5/16" holes into the rafter legs using the ground post holes as guides.
4. Secure the rafter legs to the *ground posts* using 5/16" x 3-1/2" carriage bolts, nuts, and washers as shown in the insert above.
5. Repeat the steps for the remaining end of the shelter.



## SMALL ANIMAL HUTS



### QUICK START GUIDE

Small Animal Hut (12' x 12' 2")

### ANCHORING INSTRUCTIONS

Prior to assembling this animal hut, please read the **MUST READ** document included with the shipment.

**⚠ WARNING:** The anchor assembly is an integral part of the animal hut. Improper anchoring may cause instability and failure of the structure to perform as designed. Failing to anchor the animal hut properly *will void the manufacturer's warranty* and may cause serious injury and damage.

Consult your sales representative for anchoring products and assistance. *You must anchor the assembled animal hut to the site. Anchoring components are not included with the animal hut and must be ordered separately.*

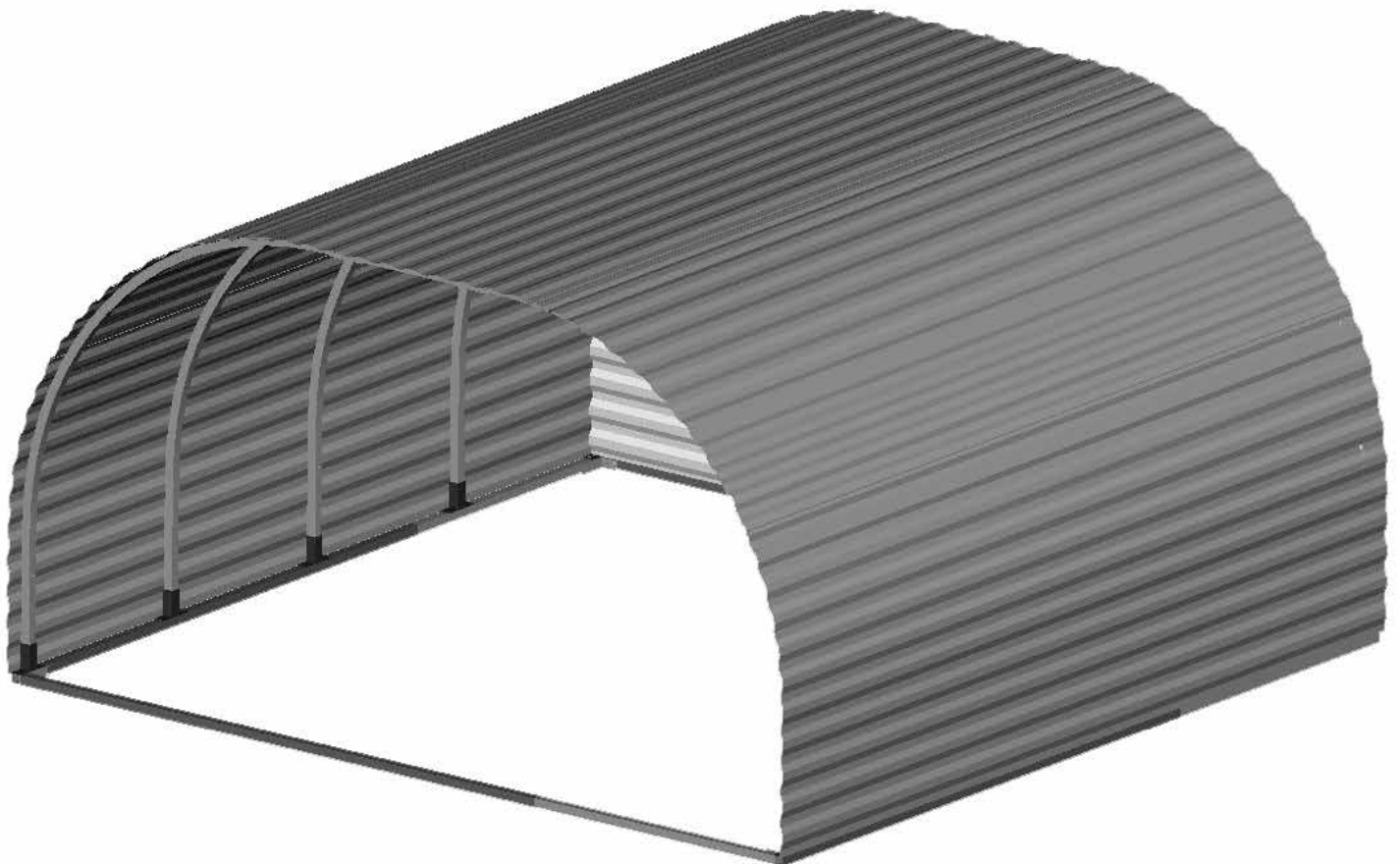
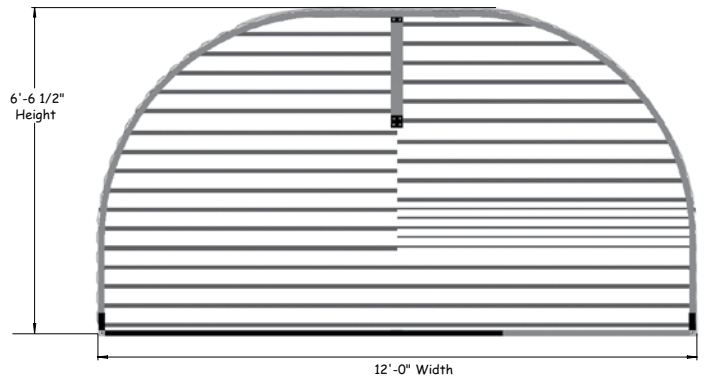

# SIDE PROFILE - 105218

